

N-Channel High Density Trench MOSFET (30V, 64A)

PRODUCT SUMMARY

V_{DSS}	I_D	$R_{DS(on)}$ (m Ω) Typ.
30V	64	3.5 @ $V_{GS} = 10V, I_D=20A$
		4.8 @ $V_{GS} = 4.5V, I_D=16A$

Features

- Super high density cell design for extremely low RDS(ON)
- Exceptional on-resistance and maximum DC current capability
- Lead (Pb) -free and halogen-free

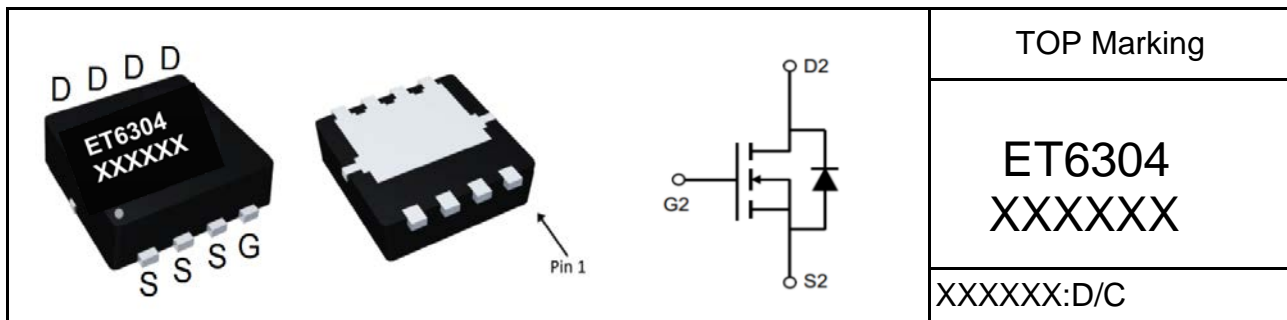

Absolute Maximum Ratings ($T_A=25^\circ\text{C}$, unless otherwise noted)

Symbol	Parameter	Ratings	Units
V_{DS}	Drain-Source Voltage	30	V
V_{GS}	Gate-Source Voltage	± 20	V
I_D	Drain Current (Continuous) @ $T_A=25^\circ\text{C}$	64	A
	Drain Current (Continuous) @ $T_A=75^\circ\text{C}$	40	A
I_{DM}	Drain Current (Pulsed) ^a	256	A
P_D	Total Power Dissipation @ $T_c=25^\circ\text{C}$	33	W
	Total Power Dissipation @ $T_{c+A1}=75^\circ\text{C}$	16	W
EAS	Avalanche energy, single pulsed ^b	49	mj
I_S	Maximum Diode Forward Current	50	A
T_j, T_{stg}	Operating Junction and Storage Temperature Range	-55 to +150	$^\circ\text{C}$
R_{QJA}	Thermal Resistance Junction to Ambient (PCB mounted) ^c	33	$^\circ\text{C/W}$

a: Repetitive Rating: Pulse width limited by the maximum junction temperature.

b: Limited by T_{Jmax} , starting $T_J = 25^\circ\text{C}$, $L = 0.5\text{mH}$, $R_G = 25\Omega$, $I_{AS} = 10\text{A}$, $V_{GS} = 10\text{V}$. Part not recommended for use above this value

c: 1-in2 2oz Cu PCB board



Electrical Characteristics (T_A=25°C, unless otherwise noted)

Symbol	Characteristic	Test Conditions	Min.	Typ.	Max.	Unit
• Off Characteristics						
BV _{DSS}	Drain-Source Breakdown Voltage	V _{GS} =0V, I _D =250uA	30	-	-	V
I _{DSS}	Zero Gate Voltage Drain Current	V _{DS} =30V, V _{GS} =0V	-	-	1	μA
I _{GSS}	Gate-Body Leakage Current	V _{GS} =±20V, V _{DS} =0V	-	-	±100	nA
• On Characteristics						
V _{GS(th)}	Gate Threshold Voltage	V _{DS} =V _{GS} , I _D =250uA	1.0	1.7	2.4	V
R _{DS(on)}	Drain-Source On-State Resistance	V _{GS} =10V, I _D =20A	-	3.5	5	mΩ
		V _{GS} =4.5V, I _D =16A	-	4.8	7	
• Dynamic Characteristics						
C _{iss}	Input Capacitance	V _{DS} =15V, V _{GS} =0V, f=1MHz	-	1930	-	PF
C _{oss}	Output Capacitance		-	310	-	
C _{rss}	Reverse Transfer Capacitance		-	260	-	
• Switching Characteristics						
Q _g	Total Gate Charge	V _{DS} =15V, I _D =6.9A, V _{GS} =10V	-	38	-	nC
Q _{gs}	Gate-Source Charge		-	5.1	-	
Q _{gd}	Gate-Drain Charge		-	12	-	
t _{d(on)}	Turn-on Delay Time	V _{DD} =15V, R _L =15Ω, I _D =1A, V _{GEN} =10V, R _G =6Ω	-	8.5	-	nS
t _r	Turn-on Rise Time		-	9	-	
t _{d(off)}	Turn-off Delay Time		-	31	-	
t _f	Turn-off Fall Time		-	9	-	
• Drain-Source Diode Characteristics						
V _{SD}	Drain-Source Diode Forward	V _{GS} =0V, I _S =20A	-	0.8	1.2	V

Note: Pulse Test: Pulse Width ≤ 300us, Duty Cycle ≤ 2%

Typical Characteristics Curves (Ta=25°C, unless otherwise note)

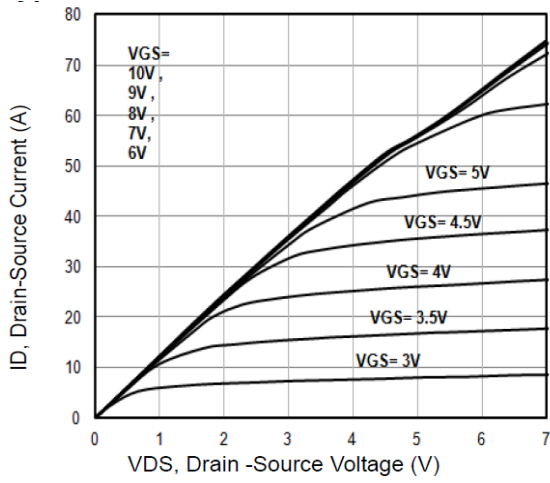

Fig1. Typical Output Characteristics

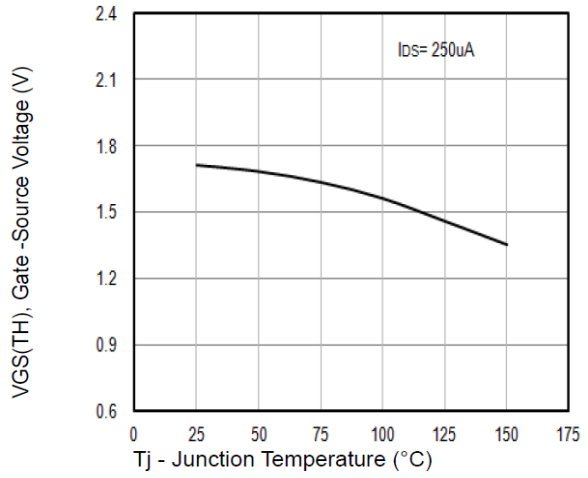

Fig2. $V_{GS(TH)}$ Gate-Source Voltage Vs. T_j

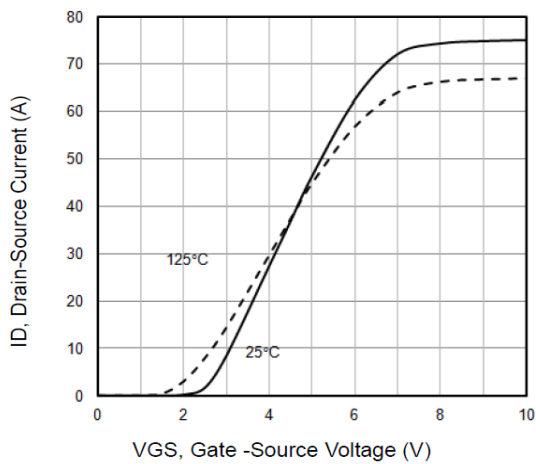

Fig3. Typical Transfer Characteristics

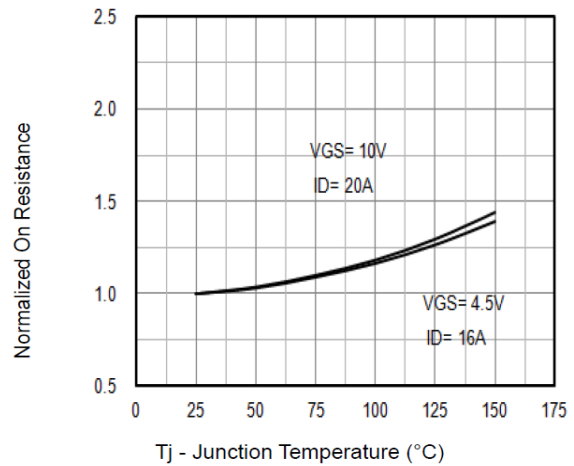

Fig4. Normalized On-Resistance Vs. T_j

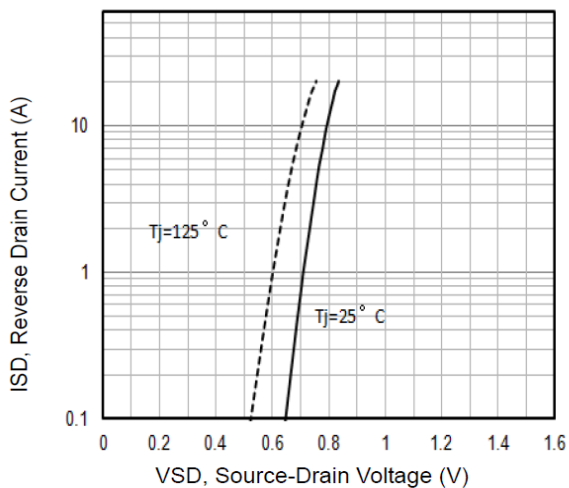

Fig5. Typical Source-Drain Diode Forward Voltage

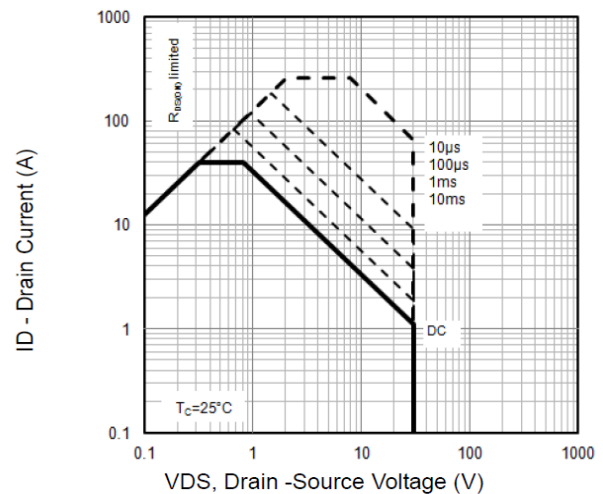

Fig6. Maximum Safe Operating Area

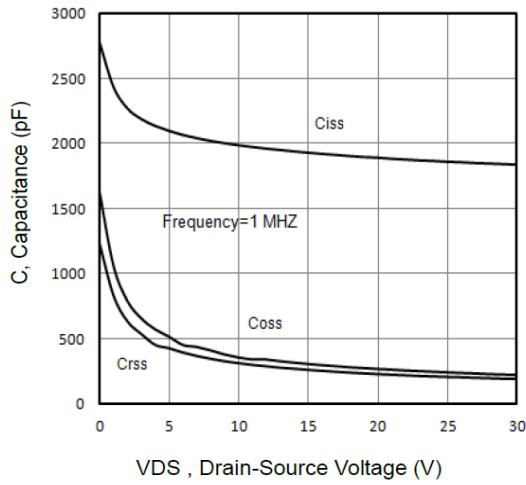

Fig7. Typical Capacitance Vs. Drain-Source Voltage

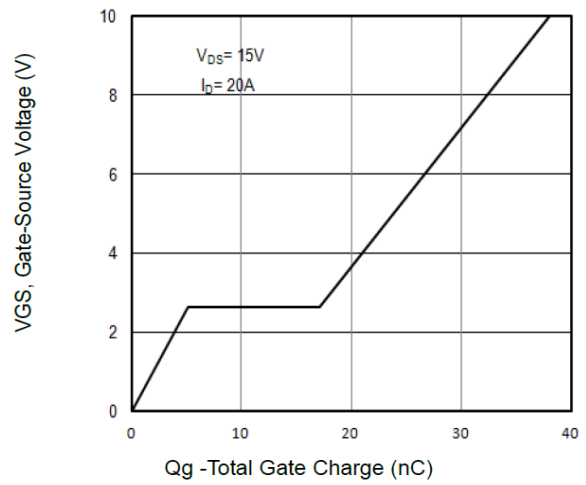

Fig8. Typical Gate Charge Vs. Gate-Source Voltage

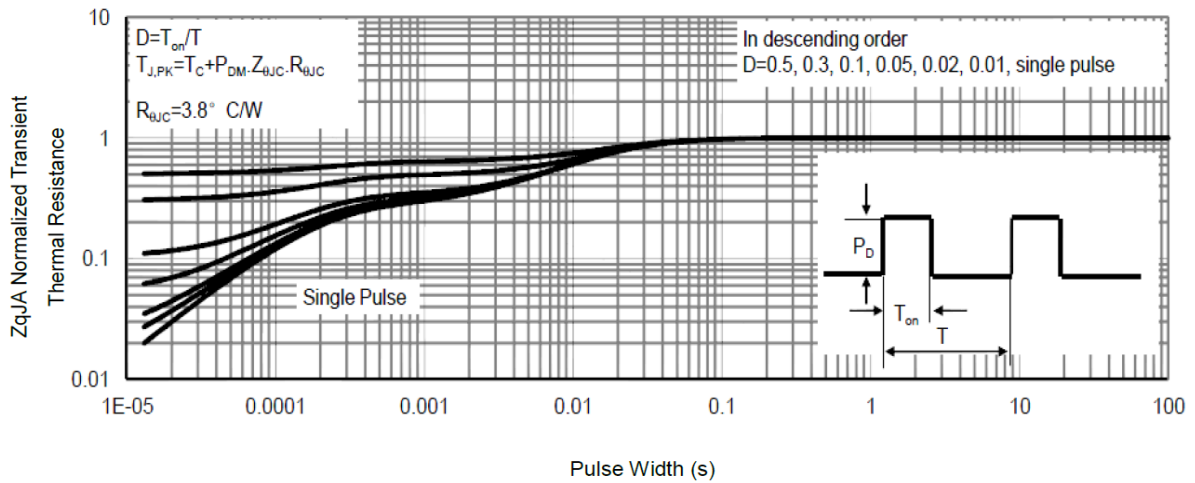

Fig9. Normalized Maximum Transient Thermal Impedance

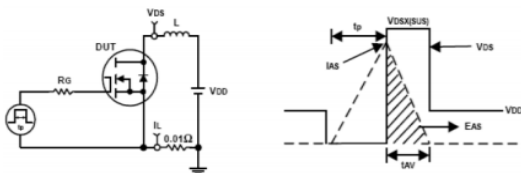

Fig10. Unclamped Inductive Test Circuit and waveforms

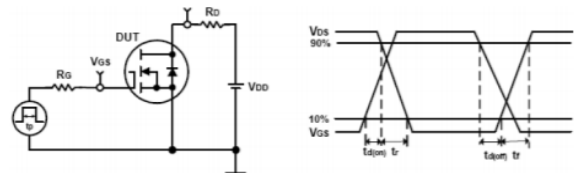
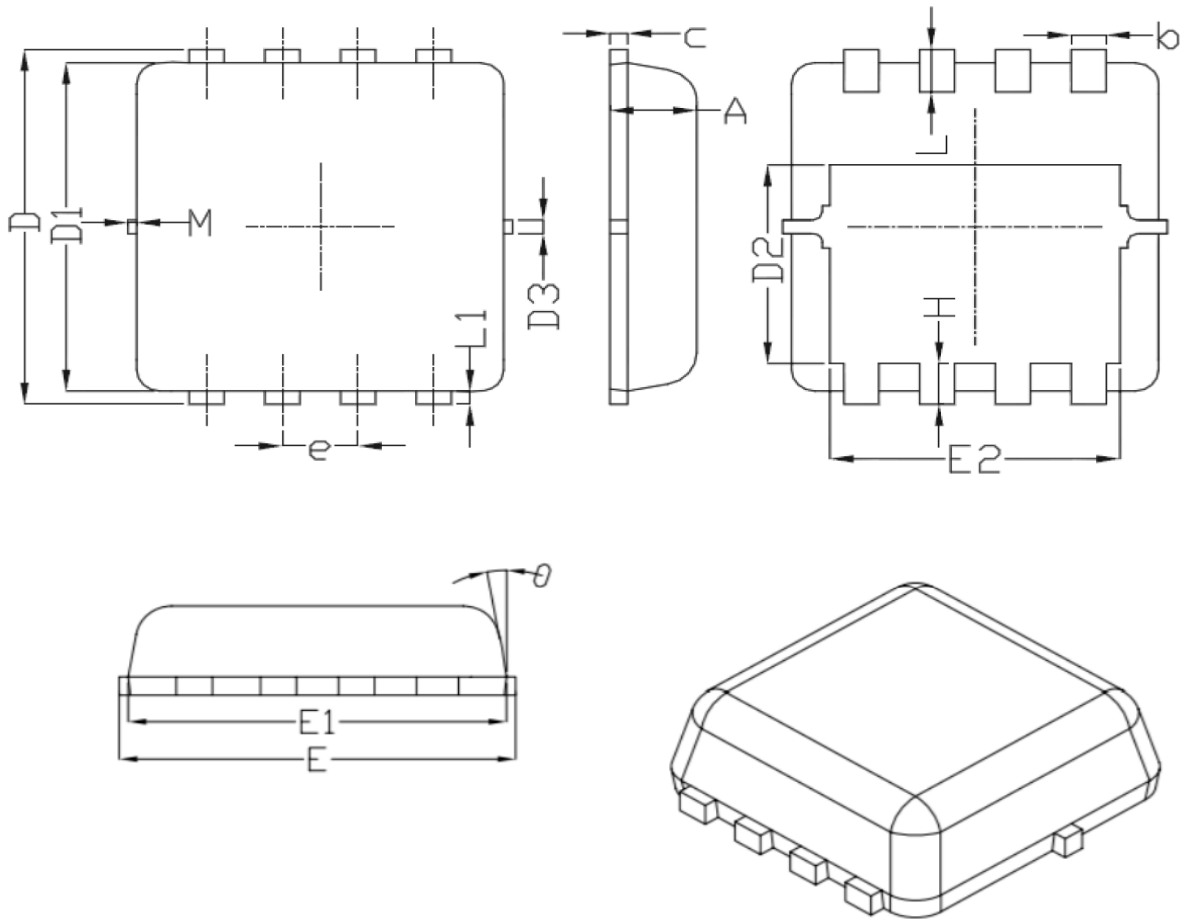

Fig11. Switching Time Test Circuit and waveforms

PDFN3333 Package Outline Data



Symbol	Dimensions (unit : mm)		
	Min	TYP	Max
A	0.70	0.75	0.8
b	0.25	0.30	0.35
c	0.10	0.15	0.25
D	3.25	3.35	3.45
D1	3.00	3.10	3.2
D2	1.78	1.88	1.98
D3	-	0.13	-
E	3.20	3.30	3.4
E1	3.00	3.15	3.2
E2	2.39	2.49	2.59
e	0.65BSC		
H	0.30	0.39	0.5
L	0.30	0.40	0.5
L1	-	0.13	-
K	0.30	-	-
θ	-	10 ⁰	12 ⁰
M	*	*	0.15