

Dual N-Channel High Density Trench MOSFET (20V, 6A)

PRODUCT SUMMARY

V_{DSS}	I_D	$R_{DS(on)}$ (m Ω) Typ.
20V	6.0A	19 @ $V_{GS} = 4.5V, I_D=6A$
		20 @ $V_{GS} = 4.0V, I_D=6A$
		25 @ $V_{GS} = 2.5V, I_D=5.2A$

Features

- Advanced Trench Process Technology
- High Density Cell Design for Ultra Low On-Resistance
- Surface mount Package
- Lead (Pb) -free and halogen-free

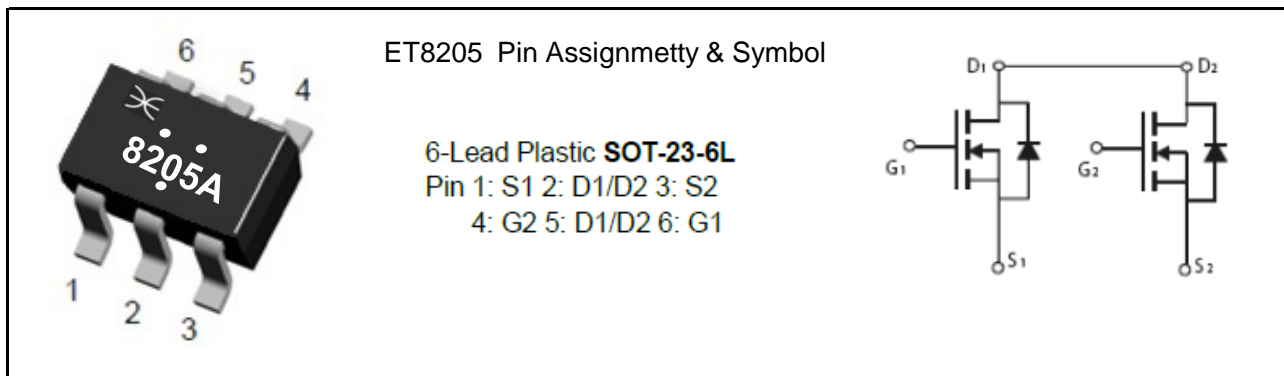

Notes :Dots are product batch information

Absolute Maximum Ratings ($T_A=25^\circ C$, unless otherwise noted)

Symbol	Parameter	Ratings	Units
V_{DS}	Drain-Source Voltage	20	V
V_{GS}	Gate-Source Voltage	± 12	V
I_D	Drain Current (Continuous)	6	A
I_{DM}	Drain Current (Pulsed) ^a	20	A
P_D	Total Power Dissipation @ $T_A=25^\circ C$	1.25	W
I_S	Maximum Diode Forward Current	1.7	A
T_j, T_{stg}	Operating Junction and Storage Temperature Range	-55 to +150	$^\circ C$
R_{QJA}	Thermal Resistance Junction to Ambient (PCB mounted) ^b	100	$^\circ C/W$

a: Repetitive Rating: Pulse width limited by the maximum junction temperature.

b: 1-in² 2oz Cu PCB board

Electrical Characteristics ($T_A=25^\circ\text{C}$, unless otherwise noted)

Symbol	Characteristic	Test Conditions	Min.	Typ.	Max.	Unit
• Off Characteristics						
BV_{DSS}	Drain-Source Breakdown Voltage	$V_{GS}=0V, I_D=250\mu A$	20	-	-	V
I_{DSS}	Zero Gate Voltage Drain Current	$V_{DS}=20V, V_{GS}=0V$	-	-	1	μA
I_{GSS}	Gate-Body Leakage Current	$V_{GS}=\pm 12V, V_{DS}=0V$	-	-	± 10	μA
• On Characteristics						
$V_{GS(th)}$	Gate Threshold Voltage	$V_{DS}=V_{GS}, I_D=250\mu A$	0.5	0.65	1	V
$R_{DS(on)}$	Drain-Source On-State Resistance	$V_{GS}=4.5V, I_D=6A$	-	19	24	m Ω
		$V_{GS}=3V, I_D=5.2A$	-	20	27	
		$V_{GS}=2.5V, I_D=5.2A$	-	25	28	
• Dynamic Characteristics						
C_{iss}	Input Capacitance	$V_{DS}=6V, V_{GS}=0V, f=1\text{MHz}$	-	450	-	PF
C_{oss}	Output Capacitance		-	110	-	
C_{rss}	Reverse Transfer Capacitance		-	89	-	
• Switching Characteristics						
Q_g	Total Gate Charge	$V_{DS}=10V, I_D=6A, V_{GS}=4.5V$	-	7	-	nC
Q_{gs}	Gate-Source Charge		-	0.9	-	
Q_{gd}	Gate-Drain Charge		-	1.4	-	
$t_{d(on)}$	Turn-on Delay Time	$V_{DD}=10V, R_L=1.2\Omega, I_D=1A, V_{GEN}=10V, R_G=6\Omega$	-	10.2	-	nS
t_r	Turn-on Rise Time		-	7	-	
$t_{d(off)}$	Turn-off Delay Time		-	33	-	
t_f	Turn-off Fall Time		-	6.8	-	
• Drain-Source Diode Characteristics						
V_{SD}	Drain-Source Diode Forward Voltage	$V_{GS}=0V, I_S=1.7A$	-	-	1.2	V

Note: Pulse Test: Pulse Width $\leq 300\mu s$, Duty Cycle $\leq 2\%$

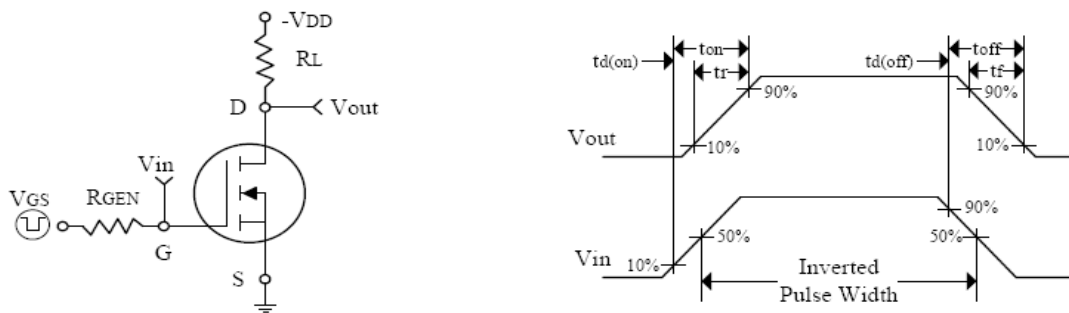

Switching Test Circuit and Switching Waveforms

Typical Characteristics Curves (Ta=25°C, unless otherwise note)

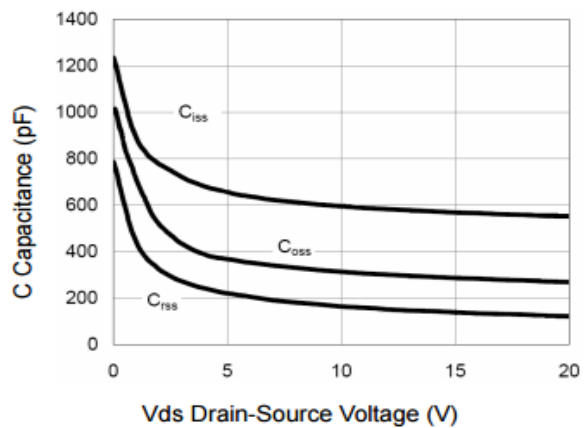
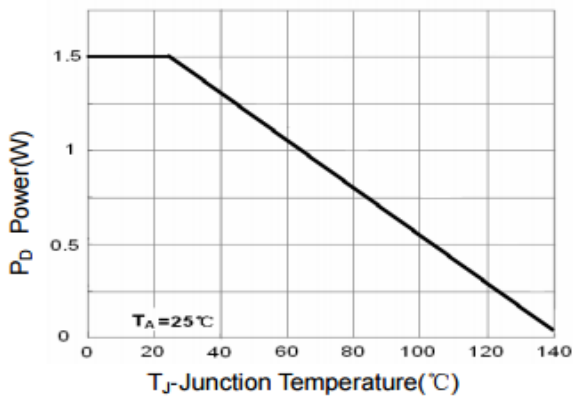
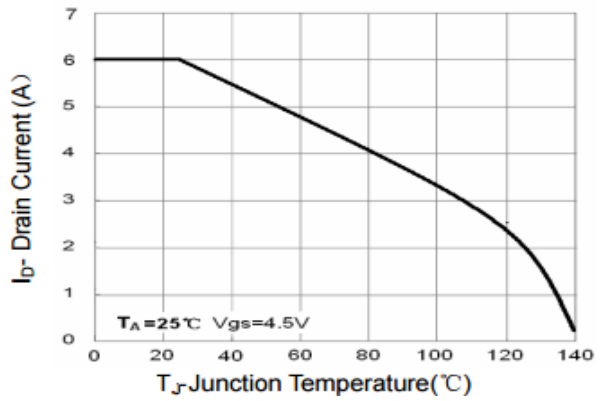
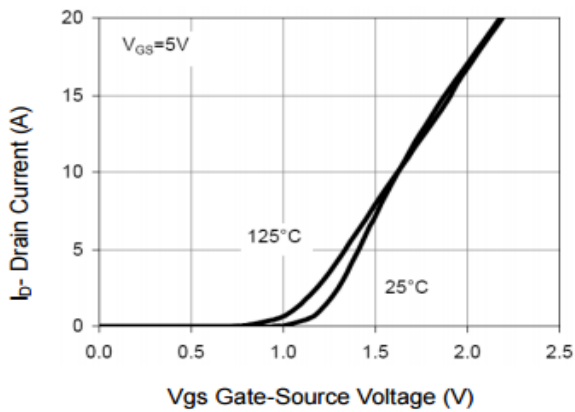
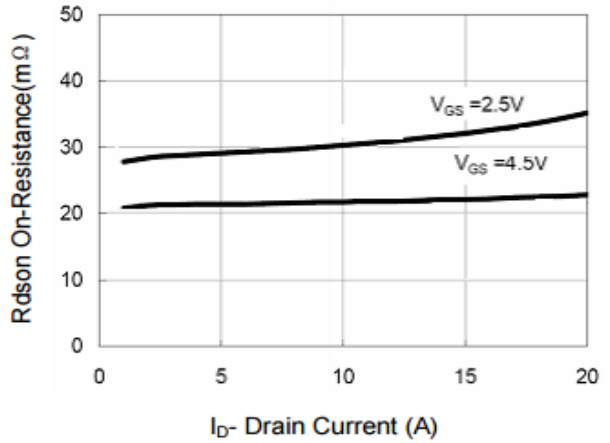
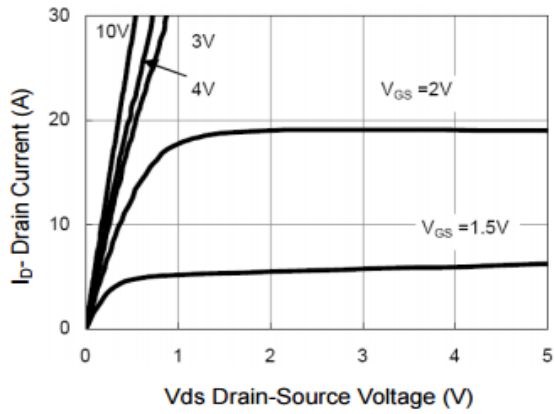

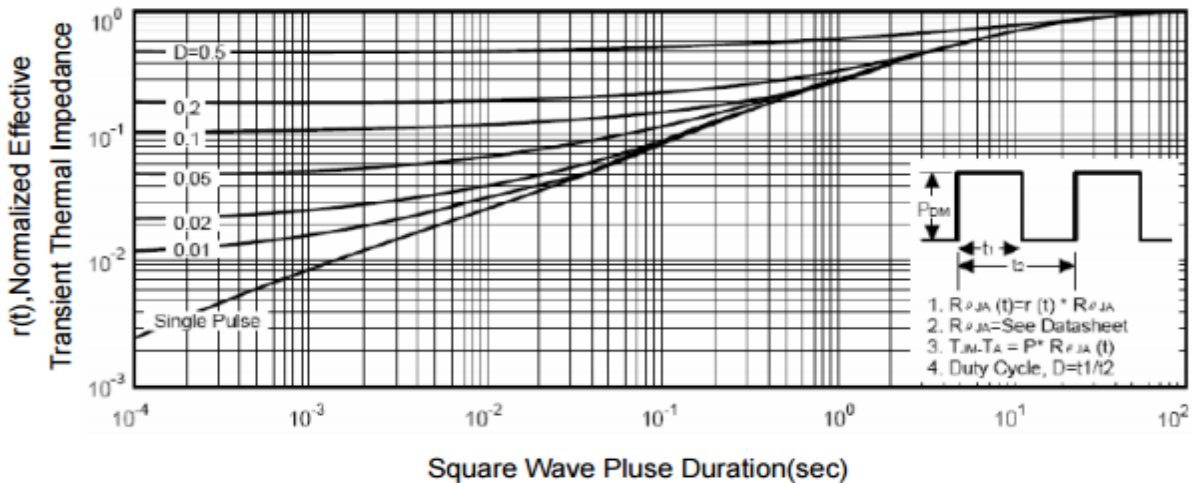
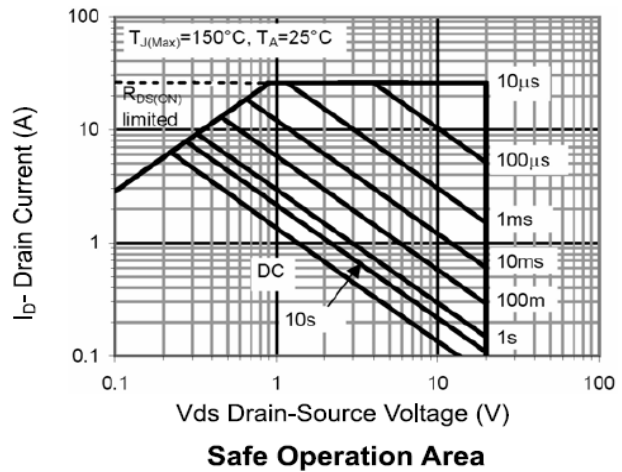
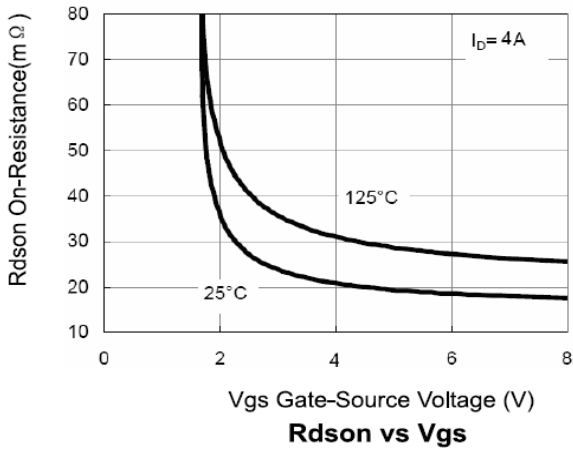
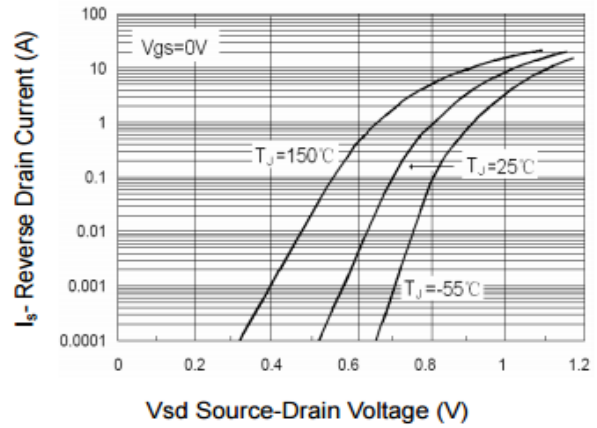
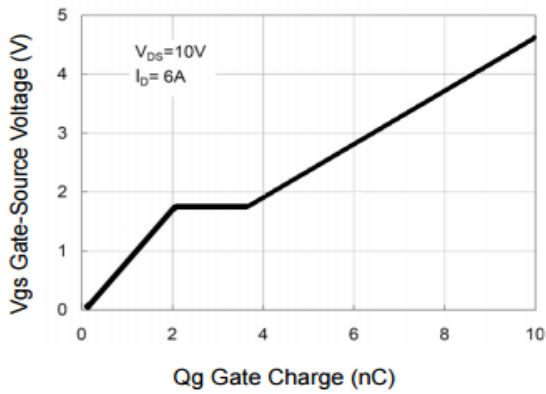

SOT23-6L PACKAGE OUTLINE DIMENSIONS

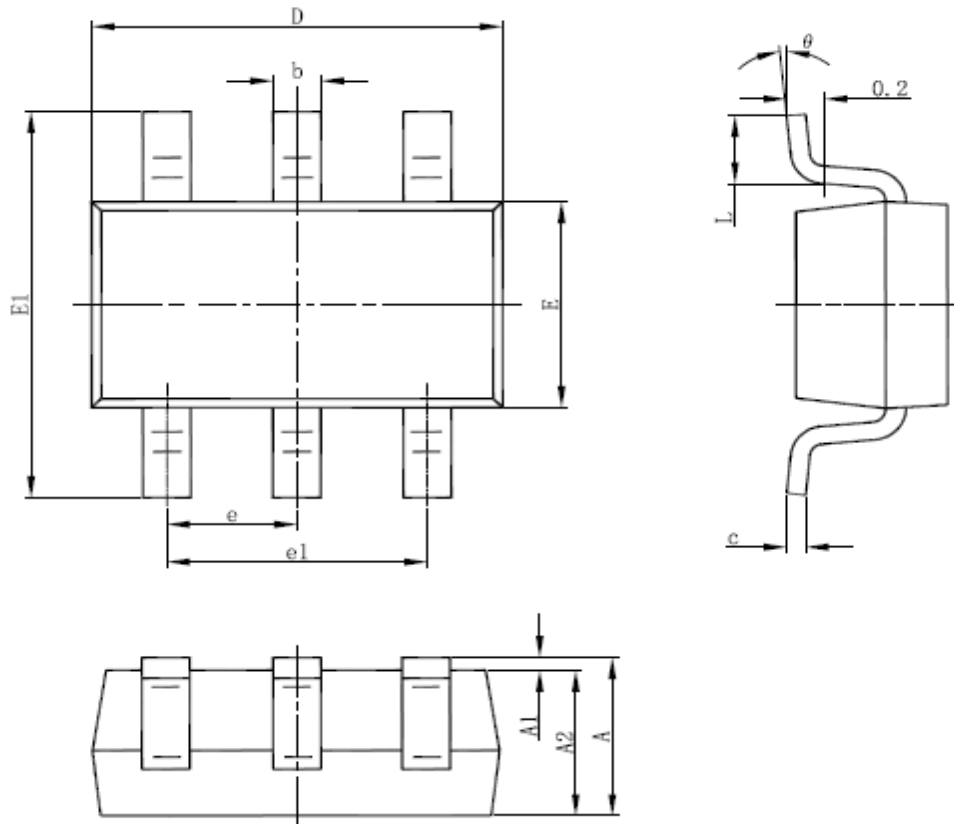

Symbol	Dimensions In Millimeters		Dimensions In Inches	
	Min	Max	Min	Max
A	1.050	1.250	0.041	0.049
A1	0.000	0.100	0.000	0.004
A2	1.050	1.150	0.041	0.045
b	0.300	0.500	0.012	0.020
c	0.100	0.200	0.004	0.008
D	2.820	3.020	0.111	0.119
E	1.500	1.700	0.059	0.067
E1	2.650	2.950	0.104	0.116
e	0.950(BSC)		0.037(BSC)	
e1	1.800	2.000	0.071	0.079
L	0.300	0.600	0.012	0.024
theta	0°	8°	0°	8°